

# FS-4xx statistics panel

Displaying fouls and points of players

## General Index

1. LIST OF STATISTICS PANEL MODELS.....	1	6. FINAL CONNECTION AND STATISTICS PANEL TEST.....	4
2. INTRODUCTION.....	2	6.1 Connecting the statistics panels.....	4
2.1 Safety warning.....	2	6.2 Testing the statistics panels.....	4
3. ASSEMBLY OF STATISTICS PANEL.....	2	7. MAINTENANCE.....	5
3.1 Joining the modules by means of brackets.....	2	7.1 Malfunctions.....	5
3.2 Electrical connection of modules.....	2	7.2 Replacing a control board.....	6
4. ELECTRICAL POWER SUPPLY SYSTEM.....	3	7.3 Replacing a LED display board.....	7
4.1 Power switch and socket .....	3	7.4 Replacing a connector board.....	7
5. INSTALLATION ON WALL.....	3	7.5 Replacing the power supply.....	8
5.1 Selecting the correct position.....	3	8. CONFIGURATION OF MODULE DIP-SWITCHES.....	9
5.2 Installing the statistics panel.....	3		

## 1. LIST OF STATISTICS PANEL MODELS

Statistics panels displaying fouls and points of players come in pairs, one for each team, and are usually installed to the right and left sides of the central scoreboard. Following are examples of the various models.

Fig. 1: **FS-412A** (art.260A)

PLYR	FOULS	PLYR	FOULS
4	✓○○○○●	4	✓○○○○●
5	✓○○○○●	5	✓○○○○●
6	✓○○○○●	6	✓○○○○●
7	✓○○○○●	7	✓○○○○●
8	✓○○○○●	8	✓○○○○●
9	✓○○○○●	9	✓○○○○●
10	✓○○○○●	10	✓○○○○●
11	✓○○○○●	11	✓○○○○●
12	✓○○○○●	12	✓○○○○●
13	✓○○○○●	13	✓○○○○●
14	✓○○○○●	14	✓○○○○●
15	✓○○○○●	15	✓○○○○●

Fig. 2: **FS-412B** (art.260B)

PLYR	FOULS	PLYR	FOULS
4	✓○○○○●	4	✓○○○○●
5	✓○○○○●	5	✓○○○○●
6	✓○○○○●	6	✓○○○○●
7	✓○○○○●	7	✓○○○○●
8	✓○○○○●	8	✓○○○○●
9	✓○○○○●	9	✓○○○○●
10	✓○○○○●	10	✓○○○○●
11	✓○○○○●	11	✓○○○○●
12	✓○○○○●	12	✓○○○○●
13	✓○○○○●	13	✓○○○○●
14	✓○○○○●	14	✓○○○○●
15	✓○○○○●	15	✓○○○○●

Fig. 3: **FS-412C** (art.260C)

PLYR	FOULS	SCORE	PLYR	FOULS	SCORE
4	✓○○○○●	88	4	✓○○○○●	88
5	✓○○○○●	88	5	✓○○○○●	88
6	✓○○○○●	88	6	✓○○○○●	88
7	✓○○○○●	88	7	✓○○○○●	88
8	✓○○○○●	88	8	✓○○○○●	88
9	✓○○○○●	88	9	✓○○○○●	88
10	✓○○○○●	88	10	✓○○○○●	88
11	✓○○○○●	88	11	✓○○○○●	88
12	✓○○○○●	88	12	✓○○○○●	88
13	✓○○○○●	88	13	✓○○○○●	88
14	✓○○○○●	88	14	✓○○○○●	88
15	✓○○○○●	88	15	✓○○○○●	88

Fig. 4: **FS-414A** (art.262A)

PLYR	FOULS	PLYR	FOULS
1	✓○○○○●	1	✓○○○○●
2	✓○○○○●	2	✓○○○○●
3	✓○○○○●	3	✓○○○○●
4	✓○○○○●	4	✓○○○○●
5	✓○○○○●	5	✓○○○○●
6	✓○○○○●	6	✓○○○○●
7	✓○○○○●	7	✓○○○○●
8	✓○○○○●	8	✓○○○○●
9	✓○○○○●	9	✓○○○○●
10	✓○○○○●	10	✓○○○○●
11	✓○○○○●	11	✓○○○○●
12	✓○○○○●	12	✓○○○○●
13	✓○○○○●	13	✓○○○○●
14	✓○○○○●	14	✓○○○○●

Fig. 5: **FS-414B** (art.262B)

PLYR	FOULS	PLYR	FOULS
1	✓○○○○●	1	✓○○○○●
2	✓○○○○●	2	✓○○○○●
3	✓○○○○●	3	✓○○○○●
4	✓○○○○●	4	✓○○○○●
5	✓○○○○●	5	✓○○○○●
6	✓○○○○●	6	✓○○○○●
7	✓○○○○●	7	✓○○○○●
8	✓○○○○●	8	✓○○○○●
9	✓○○○○●	9	✓○○○○●
10	✓○○○○●	10	✓○○○○●
11	✓○○○○●	11	✓○○○○●
12	✓○○○○●	12	✓○○○○●
13	✓○○○○●	13	✓○○○○●
14	✓○○○○●	14	✓○○○○●

Fig. 6: **FS-414C** (art.262C)

PLYR	FOULS	SCORE	PLYR	FOULS	SCORE
1	✓○○○○●	88	1	✓○○○○●	88
2	✓○○○○●	88	2	✓○○○○●	88
3	✓○○○○●	88	3	✓○○○○●	88
4	✓○○○○●	88	4	✓○○○○●	88
5	✓○○○○●	88	5	✓○○○○●	88
6	✓○○○○●	88	6	✓○○○○●	88
7	✓○○○○●	88	7	✓○○○○●	88
8	✓○○○○●	88	8	✓○○○○●	88
9	✓○○○○●	88	9	✓○○○○●	88
10	✓○○○○●	88	10	✓○○○○●	88
11	✓○○○○●	88	11	✓○○○○●	88
12	✓○○○○●	88	12	✓○○○○●	88
13	✓○○○○●	88	13	✓○○○○●	88
14	✓○○○○●	88	14	✓○○○○●	88



## 2. INTRODUCTION

This manual covers all the aspects of normal assembly, installation and maintenance of the various models of FS-4xx electronic statistics panels used for displaying players' numbers, fouls, and points (see the various models in chapter 1). It is extremely important that the statistics panel is installed correctly. Please read the manual carefully before attempting to install the panel.

### 2.1 SAFETY WARNING



The installation of this product and of the electrical system should be carried out by a qualified technician and conform with the current regulations established by the country in which the device will be installed. The system must be equipped with ground connection and protective devices.

## 3. ASSEMBLY OF STATISTICS PANEL

To ensure fast and affordable shipping, the various modules of each statistics panel are separated before shipping. These modules must be assembled before installation.

Remove the modules from their packaging. On the back of each module you will find a label indicating whether it belongs to the RIGHT or LEFT statistics panel, and its assembly position (1, 2, 3, 4), where the number 1 refers to the top position.

To assemble both right and left panels, follow the procedure for assembling a single statistics panel.

### 3.1 JOINING THE MODULES BY MEANS OF BRACKETS

Assemble the statistics panel on the floor before mounting it on the wall. Follow the directions below:

1. Make sure you have all the necessary pieces: modules for putting together the panel (see the various models in chapter 1); brackets; screws for attaching the brackets to the modules; power supply cords and flat cables for connection among modules; dowels and screws for attaching to the wall.
2. We suggest placing protective material such as cardboard on the floor to serve as a base for assembling the panel. For each panel a pair of support brackets must be assembled by uniting a top bar (in the shape of a narrow "U") to a bottom bar (in the shape of a wide "U"): overlap the top and bottom bars so that the holes are aligned. Insert the bolts and tighten them with the corresponding lock nuts (Fig. 7).
3. Place the modules face down on the floor and in numerical order according to the numbers on the back of each (Fig.8), so as to assemble the desired panel (see various models in chapter 1). Then position the two brackets above the modules and align the holes. Using the screws provided and a Phillips screwdriver, fasten the brackets to the modules (Fig. 8).

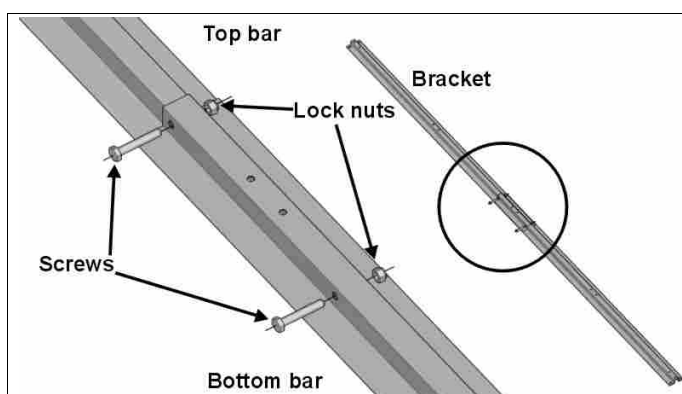

Fig. 7: Support brackets

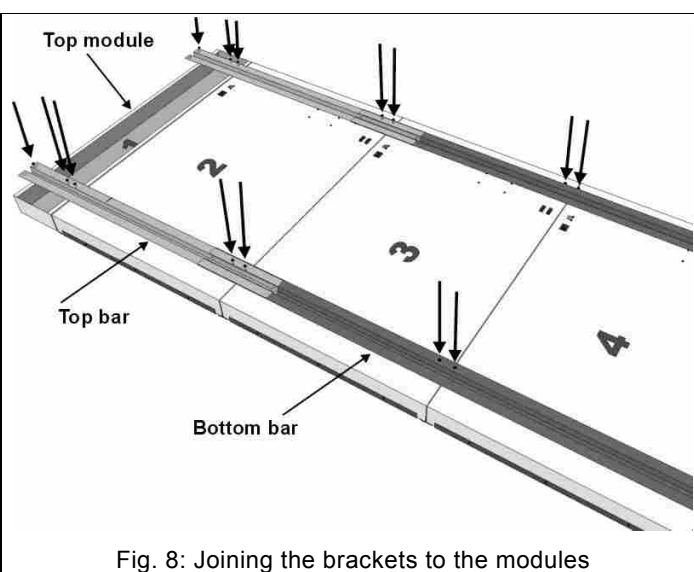

Fig. 8: Joining the brackets to the modules

### 3.2 ELECTRICAL CONNECTION OF MODULES

Once the various modules of a statistics panel have been joined together by the brackets, you may proceed to their electrical connection. On the back of each module the following connectors can be found (Fig. 9):

- a) 15-way connectors for inserting flat cables;
- b) power supply socket;
- c) "SERIAL DATA INPUT" port for connecting to the serial data cable of the central scoreboard.

Proceed as follows.

1. By using the flat cables, connect the top module to each of the other statistics panel modules (Fig. 9, Fig. 10).

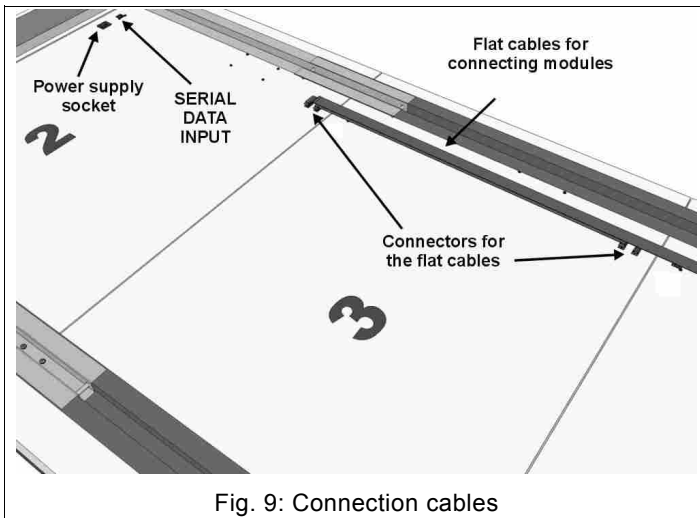

Fig. 9: Connection cables

2. Insert the power supply cord in the proper socket and fasten the other end to the top part of the panel with the clip provided for this purpose (Fig. 10); this is to enable the power supply plug to be positioned over the statistics panel once the panel is installed on the wall.
3. A 3m thin cable is provided for each statistics panel displaying fouls/points. This cable should be inserted into the "SERIAL DATA INPUT" connector and then fastened above the statistics panel by means of a provided clip. Circa 2.5 m of cable should be left free (Fig. 10) in order to make connecting to the serial data cable easier once the module has been installed on the wall .
4. Repeat the procedure for both statistics panels displaying fouls and points of players.

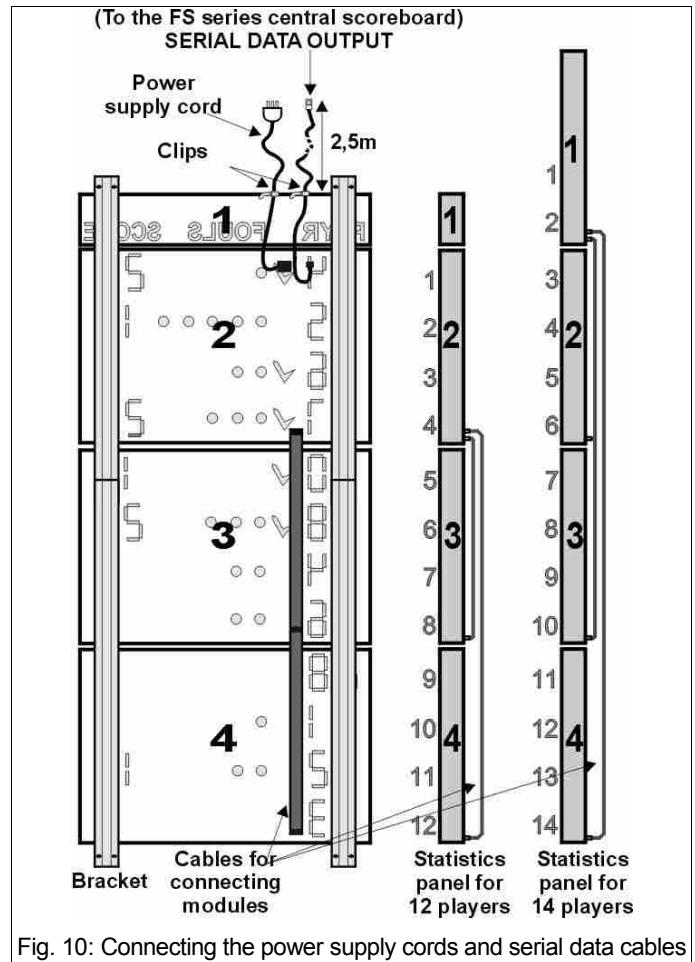

Fig. 10: Connecting the power supply cords and serial data cables

#### 4. ELECTRICAL POWER SUPPLY SYSTEM

Remember that the electrical power system should be implemented by a qualified technician.

##### 4.1 POWER SWITCH AND SOCKET

Each statistics panel comes with a power cord and plug. To turn the panel on and off easily, we suggest that a power socket be positioned just above the panel (see the example in Fig. 13). The power socket can then be controlled by a switch installed in an easy-to-reach position; this will facilitate switching off the system when not in use and help save energy and prevent unnecessary wear and tear.

#### 5. INSTALLATION ON WALL



Before installing the assembled statistics panels (see chapter 3), we suggest first running a preliminary check test (chapter 6.2) by temporarily connecting the panel to the Command Console and to the mains power supply.

##### 5.1 SELECTING THE CORRECT POSITION

Position the statistics panels on the two sides of the central scoreboard. Make sure not to invert the sides. There is a label on the back of each panel indicating its proper position of either RIGHT or LEFT. Be reminded that the FS series statistics panels are resistant to damage from balls and therefore require no additional front protection cover.



Check to make sure that the wall is strong enough to support the weight of the panels and that the dowels provided are suitable for the type of wall and environment (e.g., possible corrosion due to dampness). If the dowels are not suitable for the wall, replace them with appropriate ones. Consult a professional in the field.

##### 5.2 INSTALLING THE STATISTICS PANEL

To make installation easier, leave 5 cm of space between the central scoreboard and the panels when attaching the latter to the wall.

Before installing the statistics panel, accurately measure the distance between the two top holes on the brackets. The holes are in the shape of eyelets; therefore it is necessary that you take the measurement starting from the center of each hole.

1. Make two holes in the wall for the top brackets at the proper distance (see above). The dowels provided require holes 10 mm in diameter. Remove all dust caused by drilling from inside the holes with a high pressure air gun and cylindrical brush in order to ensure a tight hold.
2. Insert a dowel in each of the holes and then insert the screws by working the nut with a 13 mm wrench (Fig. 11); insert the washers.

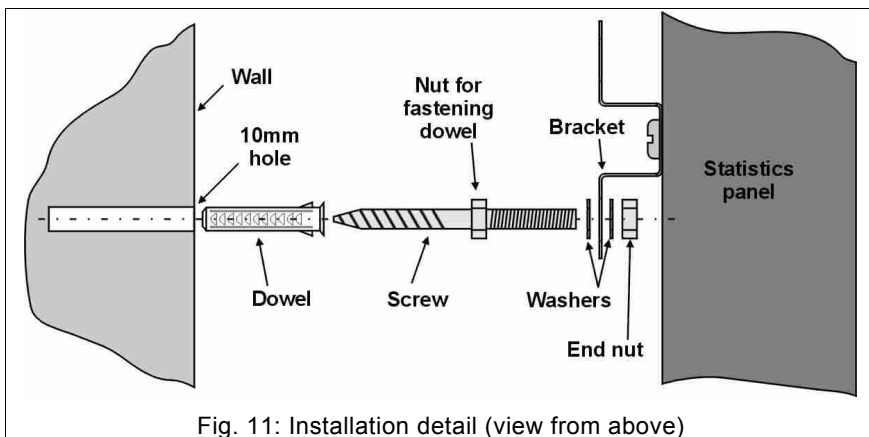

Fig. 11: Installation detail (view from above)

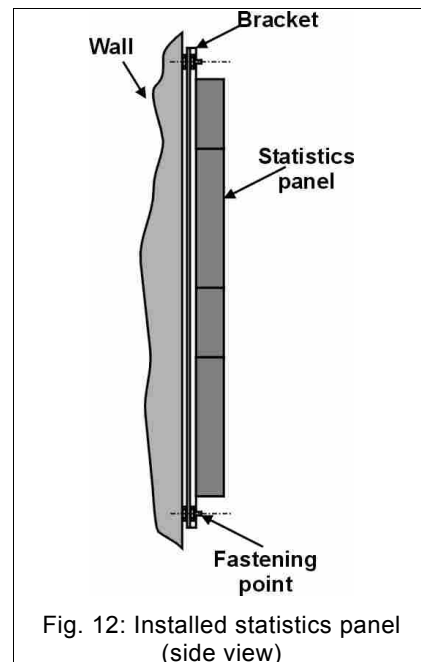

Fig. 12: Installed statistics panel (side view)

3. Fasten the statistics panel to the wall by fitting the eyelets at the top of the brackets over the screws; insert the remaining washers and end nuts, tightening them with the 13 mm wrench.

The statistics panel is now adequately installed. However, seeing that there are also lower bracket eyelets, you may also wish to fasten the bottom part of the panel to the wall; this will help to prevent possible oscillation. Proceed as follows.

4. Once the panel is fastened to the wall by the top nuts, make two additional holes in the wall through the eyelets at the bottom of the brackets. After drilling remove all dust from holes.

5. Slightly loosen the top end nuts and distance the bottom part of the board from the wall in order to insert the dowels in the holes; then insert the screws (tightening them with the 13 mm wrench) and washers. Reposition the panel close to the wall, making sure the screws pass through the eyelets at the bottom of the brackets.

6. Insert the washers and tighten both the top and bottom end nuts.



Make sure that you have securely fastened the panel to the wall in order to prevent possible collapse and harm to persons or objects.

## 6. FINAL CONNECTION AND STATISTICS PANEL TEST

Once the statistics panel has been installed on the wall, you can proceed with connecting the electrical power supply and serial data cable.

### 6.1 CONNECTING THE STATISTICS PANELS

Fig. 13 shows a configuration of the central scoreboard, the side statistics panels displaying fouls/points of players, and the lower scoreboard displaying penalty times.

1. Make sure you have disconnected the power supply by turning off the scoreboard switch.
2. Using the adapter provided, connect the panels displaying fouls/points of players to one of the two "SERIAL DATA OUTPUT" cables of the central scoreboard (Fig. 13).
3. Insert the power cord plug for each panel into the proper wall socket.

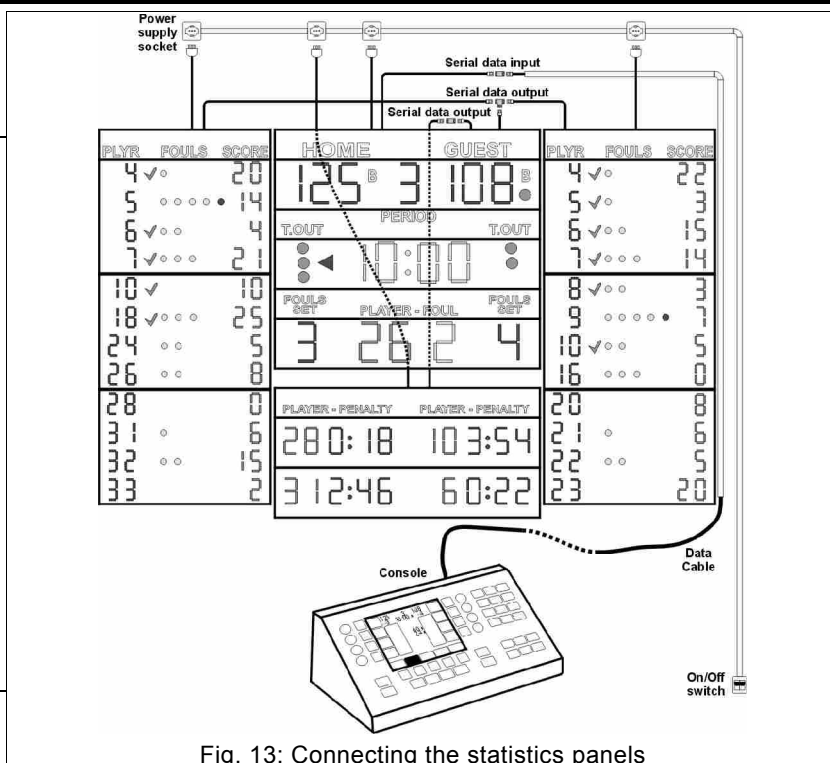







Fig. 13: Connecting the statistics panels

### 6.2 TESTING THE STATISTICS PANELS

Once the statistics panels have been installed on the wall you can make an overall test to see if all information is displayed correctly.

1. The first test should be made when you first switch on the scoreboard. All display panels should remain illuminated for circa 1 second, even if the Command Console is turned off or disconnected. If a panel does not remain illuminated for circa 1 second, see paragraph 7.1.1.
2. The next step is to connect the serial data cable to the Command Console. After switching on the Console, the screens should light up to display the proper information. If the screens do not light up, see paragraph 7.1.2.

3. Once you have checked that the data connection works properly, you can make a complete start-up test of all display boards. From the Command Console press the buttons  → , then with the buttons  and  select the parameter “Scoreboard Test”; lastly, with the buttons  and , modify the parameter in order to activate and deactivate the complete start-up of the scoreboard. If you encounter problems, consult the Command Console manual.

For incomplete display of panels, see chapter 7.1.

## 7. MAINTENANCE

This chapter contains information on how to quickly resolve the principal problems that may occur with the statistics panel over time. For problems with the central scoreboard, consult the relative installation manual.

If you have further problems that cannot be solved herein, please contact us.

For all malfunctions, the following is a list of operations, ranked according to priority, that should be carried out to re-establish the statistics panel's proper functioning.

### 7.1 MALFUNCTIONS

#### → 7.1.1 The statistics panel does not light up when switched on.

When the statistics panel is supplied with electricity, all the display panels light up for circa 1 second, even if the Command Console is turned off or disconnected. If this does not occur, proceed as follows:

1. Check that there is sufficient power supply at the panel's power socket.
2. Make sure that the panel's power cable plug is properly inserted in the socket.
3. Have a qualified technician conduct the following operations:
  - a) open the top statistics panel module, as described in chapter 7.2, points 1-5;
  - b) check that there is a continuous +24 Vdc voltage output from the power supply (the red LED on the connector board should be illuminated). If the +24Vdc voltage is not present then replace the power supply (chapter 7.5), otherwise replace the electronic connector board (chapter 7.4).

#### → 7.1.2 The statistics panel lights up for 1 second but then switches off completely.

1. Check that the Console has enabled the players' statistics.
2. Check that the serial data cable is properly connected to the statistics panel and to the Command Console and that there are no signs of abrasions, cuts or damage.
3. Try using the other data output port of the Command Console.
4. Temporarily connect the statistics panel directly to the Console with a normal 8-way telephone cable with RJ-45 modular connectors, or with a standard straight-through network cable (EIA/TIA-568A/B). If the panel functions correctly, replace the permanent system's serial data cable.
5. Have a qualified technician conduct the following operations:
  - a) open the top statistics panel module, as described in chapter 7.2, points 1-5;
  - b) connect the Console directly to the serial data connector of the connector board (Fig. 20) by means of a properly functioning serial cable. Supply power to the statistics panel;
  - c) if the panel still does not light up, disconnect the power supply and replace the electronic connector board (chapter 7.4), otherwise replace the serial data cable that was previously connected to the board.

#### → 7.1.3 Part or all of a LED display board does not light up.

1. Replace the relative LED display board (chapter 7.3).
2. Change the connection cable between the LED display board and the control board (Fig. 18).
3. Replace the control board (chapter 7.2).

#### → 7.1.4 The board is not bright enough.

1. On the Command Console press the buttons  →  and check the level of brightness [0 to 9] found under the item “Scoreboard luminosity”.

#### → 7.1.5 An entire group of LED boards does not light up in one of the statistics panel's modules.

1. Have a qualified technician conduct the following operations:
  - a) open the statistics panel module, as described in chapter 7.2, points 1-5;
  - b) identify the control board connected to the group of malfunctioning LED display boards via the 10-way flat cables (Fig. 18). When supplying power to the panel, if the LED on that control board (Fig. 18) is illuminated or flashing, then replace the control board (chapter 7.2); otherwise, if the LED is not illuminated, proceed as follows:
  - c) locate the connector board inside the top module of the statistics panel (Fig. 20). Identify the fuse (Fig. 21) near the connector where the 16-way flat cable from the previous control board has been inserted; replace the fuse if it has ruptured, otherwise replace the connector board (chapter 7.2).

## 7.2 REPLACING A CONTROL BOARD

This procedure can be done without having to de-install the statistics panel.



1. Disconnect the electronic statistics panel's power supply.

2. With a Phillips screwdriver remove a side bracket from the module containing the board in need of replacement; do this by unscrewing the three screws located on the side bracket (Fig. 14).

3. Remove the transparent front panel (Fig. 15).

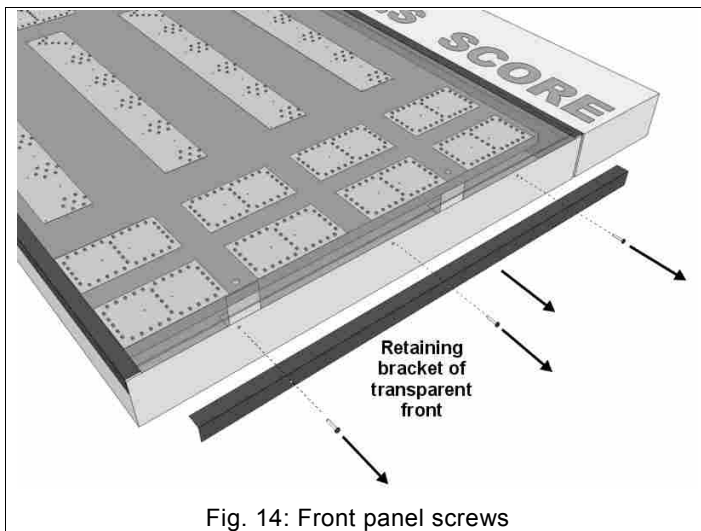

Fig. 14: Front panel screws

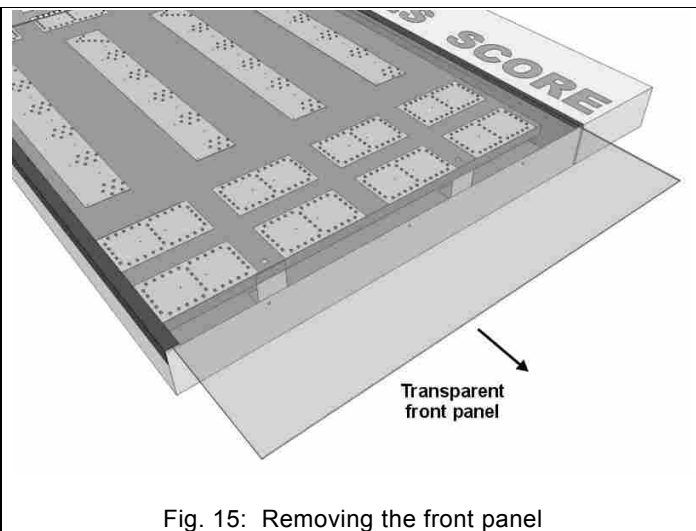

Fig. 15: Removing the front panel

4. With a Phillips screwdriver remove the two screws from the right side of the metal support of the LED display boards (Fig. 16).

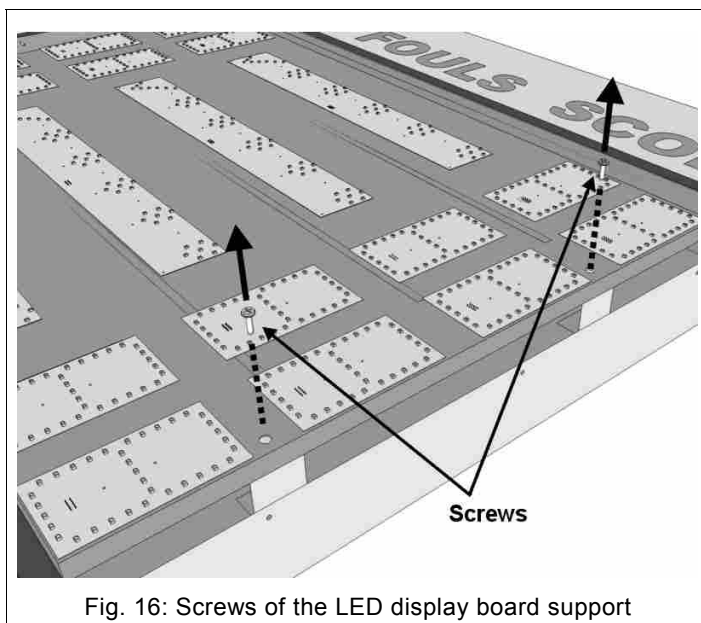

Fig. 16: Screws of the LED display board support

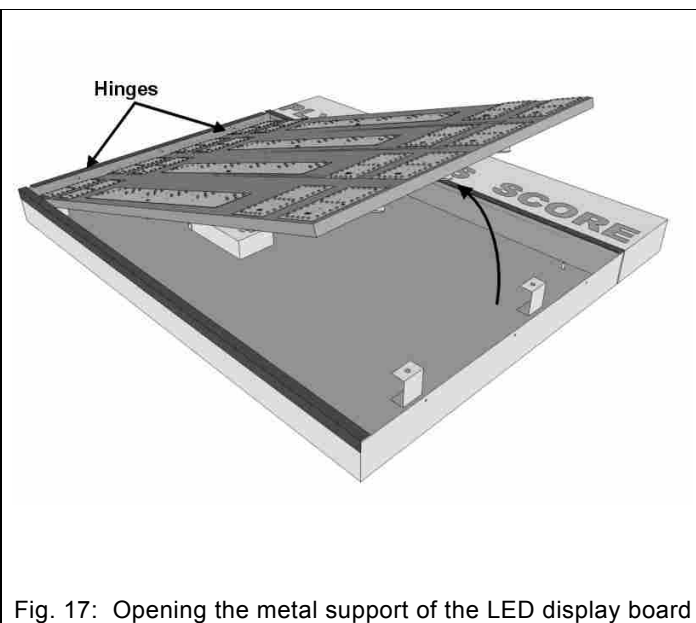

Fig. 17: Opening the metal support of the LED display board

5. Rotate the LED board support (Fig. 17) using the hinges on the left side as a pivot.

6. Identify the control board(s) housed inside of the support structure (Fig. 18); the malfunctioning LED display boards are connected to this control board. Keeping in mind their original positions, remove all the connectors from the control board.

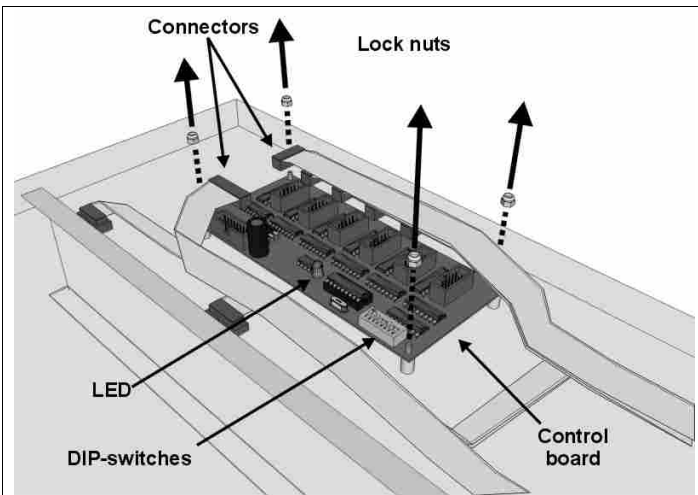

Fig. 18: Replacing a control board

7. With a 5.5 mm wrench, unscrew the 4 end nuts from the control board (Fig. 18) and remove the control board from its casing.
8. Set the DIP-switches of the new control board to the same settings of those of the replaced control board (chapter 8) and fasten the new board into the casing.
9. Reinsert the control board's connectors in their original positions. Close the metal support structure of the LED display boards and fasten it with the screws.
10. Supply power to the statistics panel again to check if the new control board works properly.

**7.3 REPLACING A LED DISPLAY BOARD**

This procedure can be done without having to de-install the statistics panel.

1. Remove the transparent front panel of the module containing the LED display board in need of replacement, as described in chapter 7.2, paragraphs 1-3.
2. With a screwdriver, remove the screws from the LED display board in need of replacement (Fig. 19); slightly distance the board from its position in order to remove the flat cable connector.
3. Insert the flat cable connector in the new board and then fasten the board with the screws.
4. Supply power to the board again to check if the display board works properly.

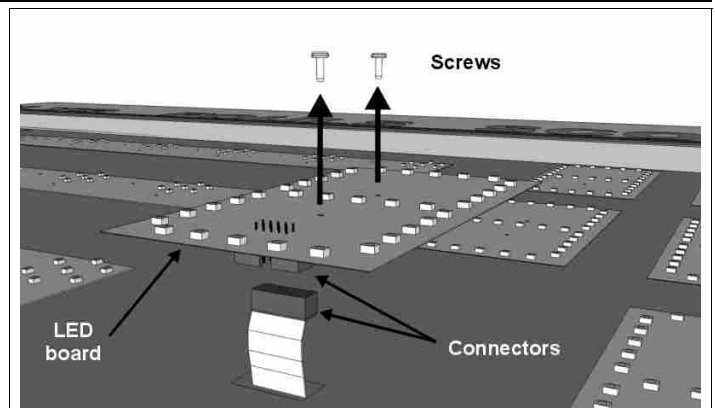
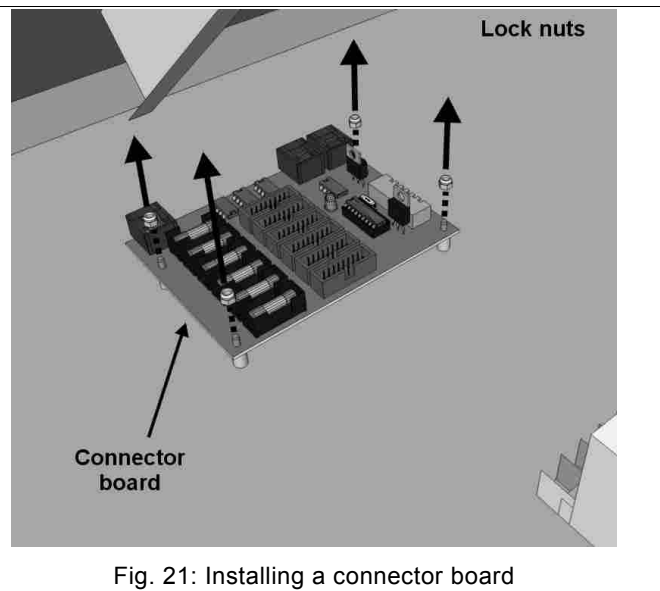
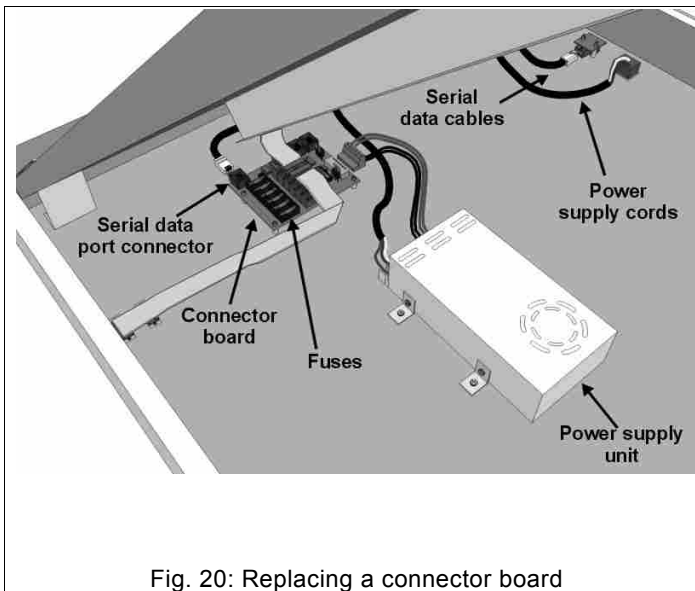

Fig. 19: Removing a LED display board

**7.4 REPLACING A CONNECTOR BOARD**

This procedure can be done without having to de-install the statistics panel.

1. Remove the transparent front panel from the top module of the statistics panel containing the connector board in need of replacement. Open the module by lifting the LED display board's support structure as described in chapter 7.2, paragraphs 1-5.
2. Identify the connector board (Fig. 20); keeping in mind their original positions, remove all the connectors from inside the board.
3. With a 5.5 mm wrench unscrew the 4 end nuts from the connector board (Fig. 21) and remove the board from its casing. Insert the new connector board.
4. Reinsert the board connectors in their original positions and then close and fasten the metal support of the LED display board with the screws.
5. Supply power to the statistics panel again to check if the new connector board works properly.



**7.5 REPLACING THE POWER SUPPLY**

This procedure can be done without having to de-install the statistics panel.

1. Remove the transparent front panel from the top module containing the power supply unit in need of replacement. Open the module by lifting the metal support of the LED display board as described in chapter 7.2, paragraphs 1-5.
2. Identify the power supply in need of replacement (Fig. 22); keeping in mind their original positions, disconnect the cables from the terminal block with a Phillips screwdriver.
3. With the same screwdriver, remove the four screws (Fig. 22) located on the sides of the power supply unit and remove it from its position.
4. Place the new power supply unit into position and fasten with screws. Then reconnect the cables to the terminal block while keeping in mind their correct positions (Table 1).
5. Close the metal support of the LED display boards and fasten it with the screws.
6. Supply power to the statistics panel again to check if it works properly.

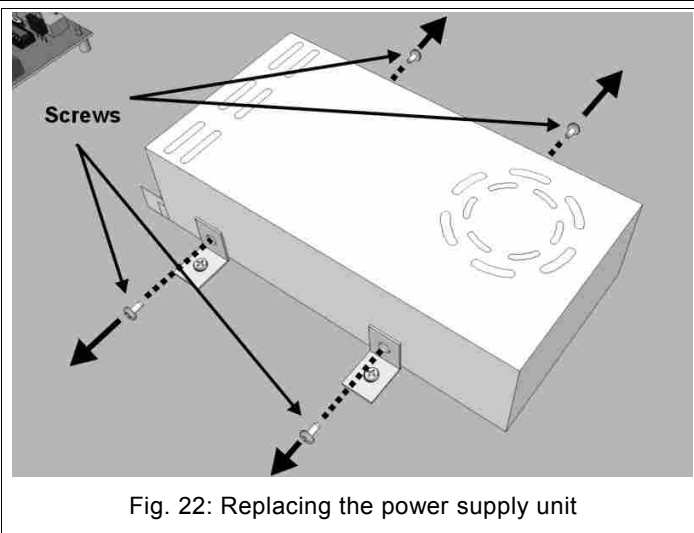

+V		-V		PE	N	L
Red	Red	Black	Black	Yellow Green	Blue	Brown

Table 1: Terminal block of power supply



**8. CONFIGURATION OF MODULE DIP-SWITCHES**

This chapter shows the configuration of the control board's DIP-switches located inside each statistics panel module. The configuration of the DIP-switches determines the information that will be displayed by the module.

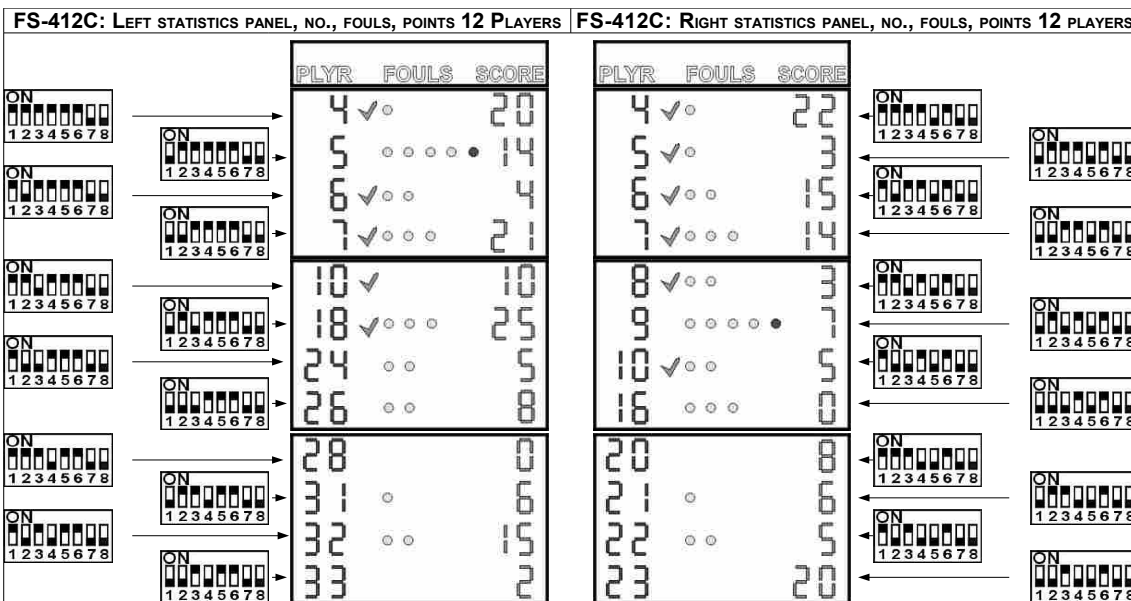
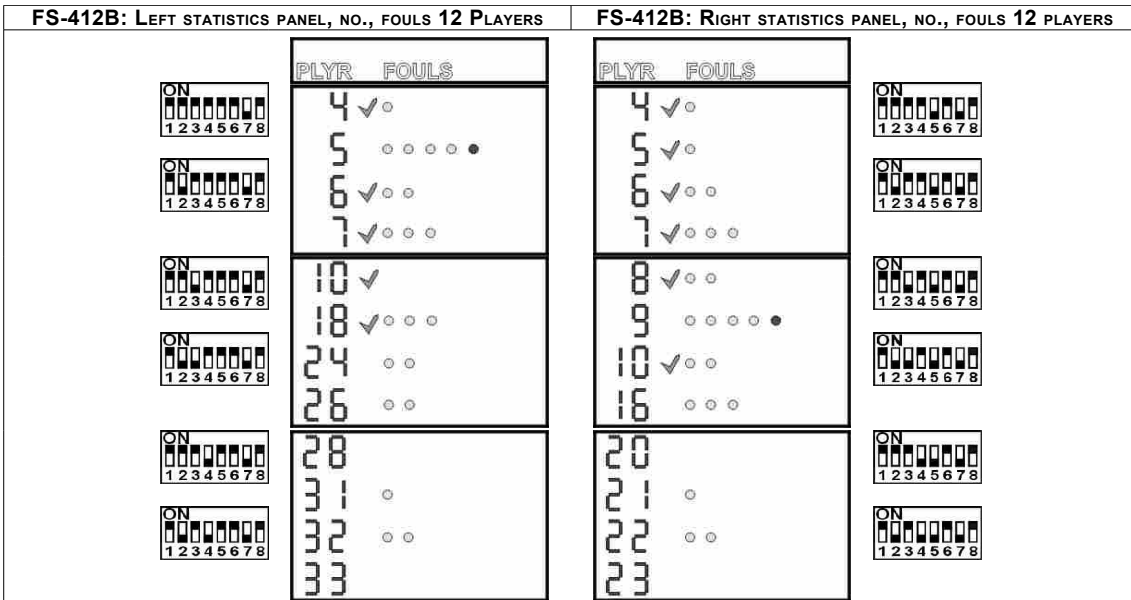
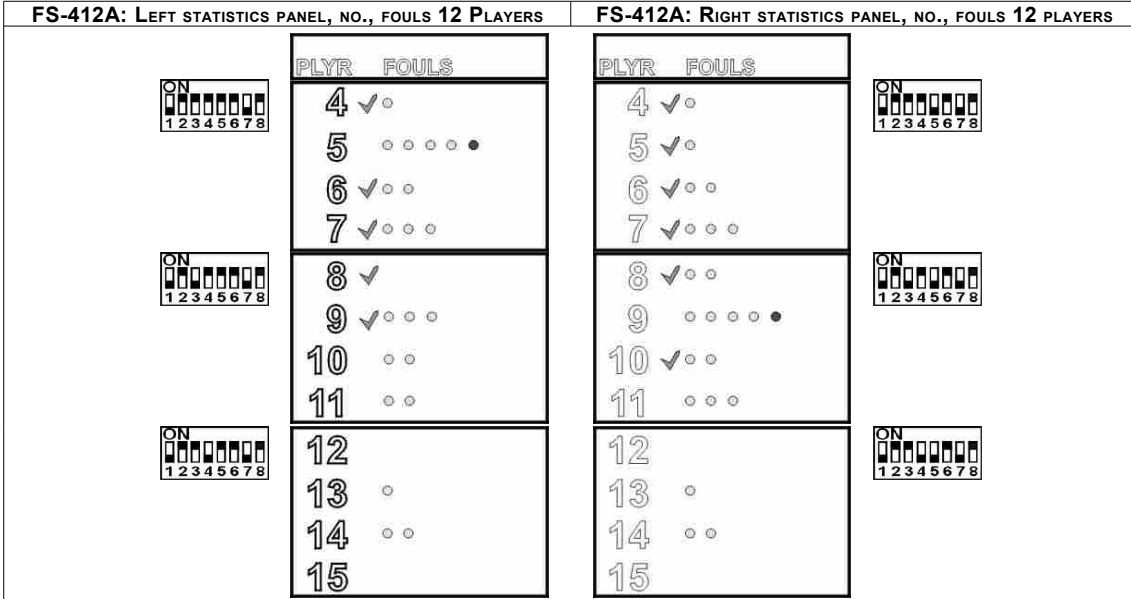

FS-414A: LEFT STATISTICS PANEL, NO., FOULS 14 PLAYERS		FS-414A: RIGHT STATISTICS PANEL, NO., FOULS 14 PLAYERS	
	PLYR FOULS SCORE	PLYR FOULS SCORE	
	1 ✓	1 ✓	
	2 ..... •	2 ✓	
	3 ✓ • •	3 ✓ • •	
	4 ✓ • • •	4 ✓ • • •	
	5 ✓	5 ✓ • •	
	6 ✓ • • •	6 ..... •	
	7 • •	7 ✓ • •	
	8 • •	8 • •	
	9	9 • •	
	10 •	10 •	
	11 • •	11 • •	
	12	12	
	13 • •	13	
	14	14 •	

FS-414B: LEFT STATISTICS PANEL, NO., FOULS 14 PLAYERS		FS-414B: RIGHT STATISTICS PANEL, NO., FOULS 14 PLAYERS	
	PLYR FOULS SCORE	PLYR FOULS SCORE	
	4 ✓	4 ✓	
	5 ✓	5 ✓	
	6 ✓ • •	6 ✓ • •	
	7 ✓ • • •	7 ✓ • • •	
	10 ✓	8 ✓ • •	
	18 ✓ • • •	9 ..... •	
	24 • •	10 ✓ • •	
	26 • •	16 • •	
	28	20	
	31 •	21 •	
	32 • •	22 • •	
	33	23	
	42 • •	44	
	53	46 •	

FS-414C: LEFT STATISTICS PANEL, NO., FOULS, POINTS 14 PLAYERS		FS-414C: RIGHT STATISTICS PANEL, NO., FOULS, POINTS 14 PLAYERS	
	PLYR FOULS SCORE	PLYR FOULS SCORE	
	4 ✓ 20	4 ✓ 22	
	5 ..... • 14	5 ✓ 3	
	6 ✓ • • 4	6 ✓ • • 15	
	7 ✓ • • • 21	7 ✓ • • • 14	
	10 ✓ 10	8 ✓ • • 3	
	18 ✓ • • • 25	9 ..... • 7	
	24 • • 5	10 ✓ • • 5	
	26 • • 8	16 • • 0	
	28 0	20 • • 8	
	31 • 6	21 • 6	
	32 • • 15	22 • • 5	
	33 2	23 0	
	42 • • 3	44 6	
	53 0	46 • 0	